

32 GALLON TOP LOAD ROUND TRASH CONTAINER

REV #4
4/7/2023

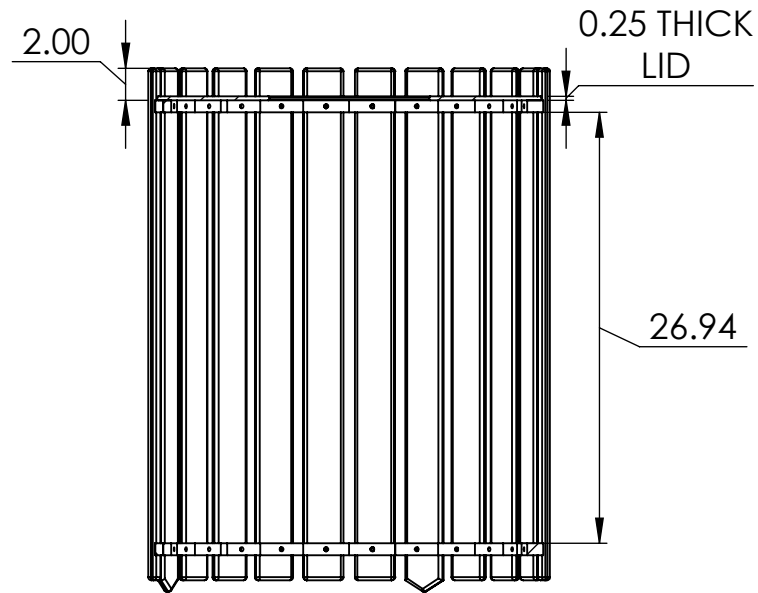
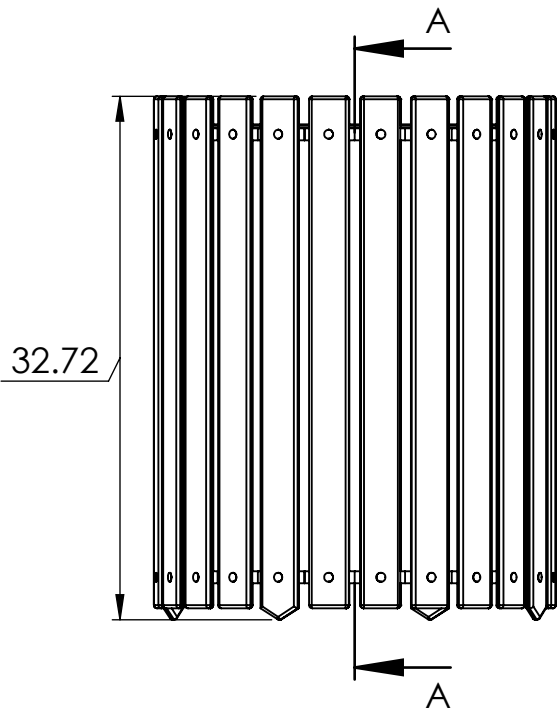
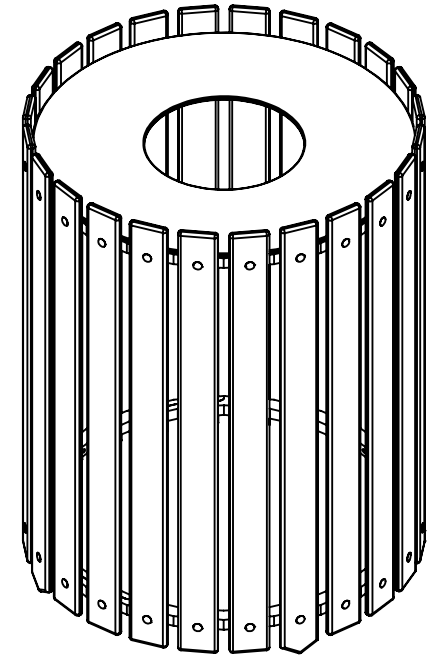
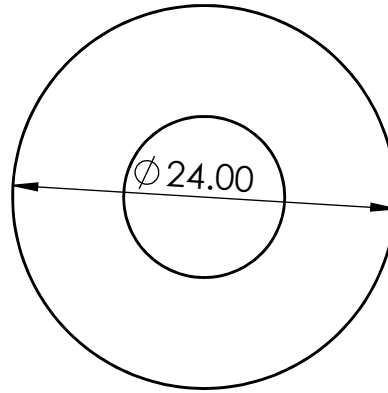
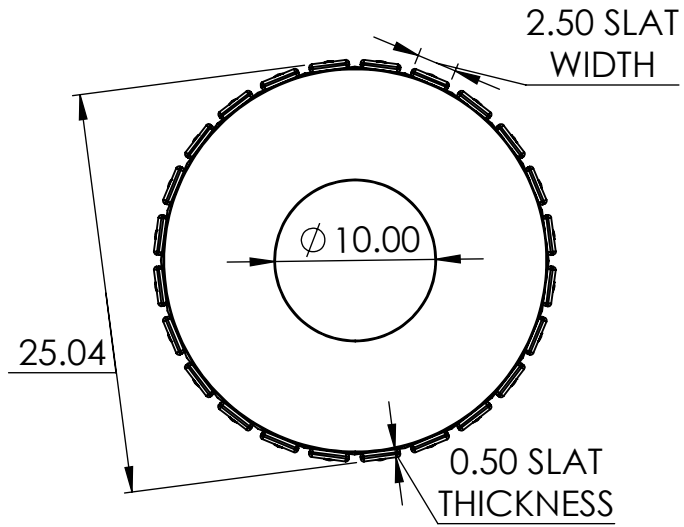

SECTION A-A
SCALE 1 : 12

SLATS - 1/2 X 2 1/2 RECYCLED PLASTIC LUMBER
FRAME - RECYCLED PLASTIC LUMBER

CONFIGURATION:
LINER - 32 GALLON
LID - FLAT
LOAD - TOP
CONSTRUCTION MATERIALS:
SLATS - 1/2 X 2 1/2 RECYCLED PLASTIC LUMBER
FRAME - RECYCLED PLASTIC LUMBER
HARDWARE:
STAINLESS STEEL, ALUMINUM