

# INSTRUCTIONS

## PW1010 - PW1012

APW1010-12 REV# 1  
11/20/2014

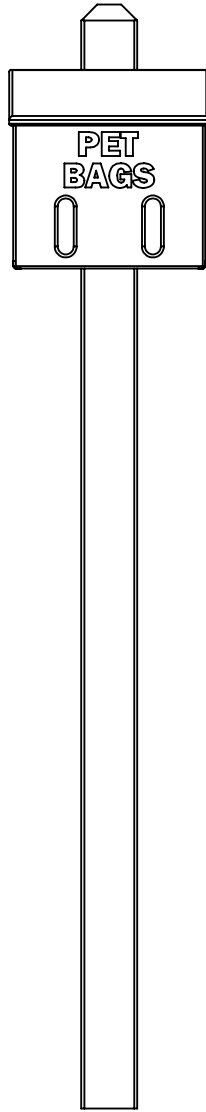

INGROUND MOUNT

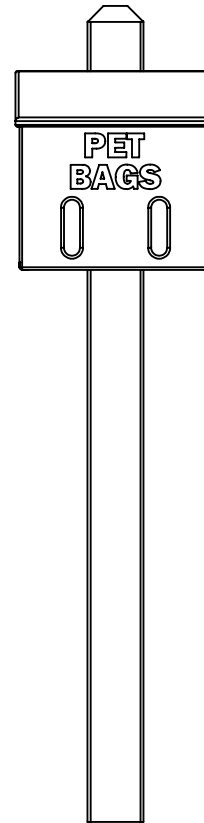

SURFACE MOUNT

# INSTRUCTIONS PW1010 - PW1012

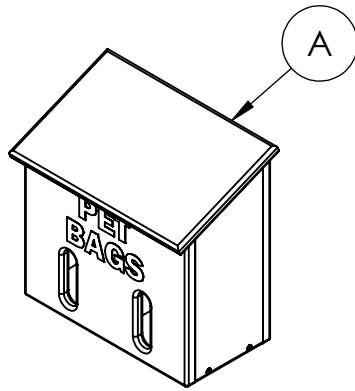

**1**  
Pet Bags Dispenser

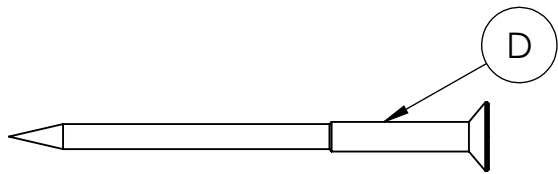

**2**  
#10 x 2.5" Screw

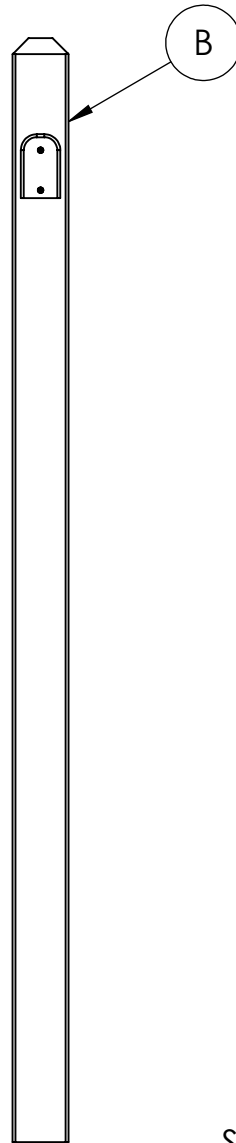

**1**  
Inground Post

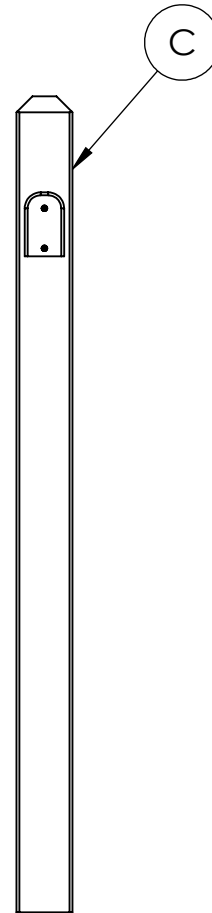

**1**  
Surface Mount Post

## SURFACE MOUNT HARDWARE

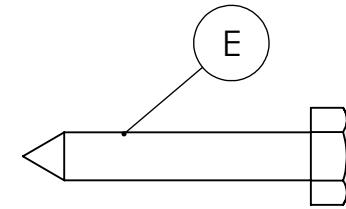

**2**  
1/4" x 1.5" Lag Screw

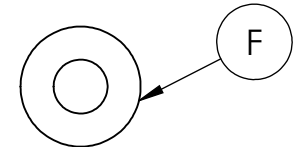

**2**  
1/4" Flat Washer

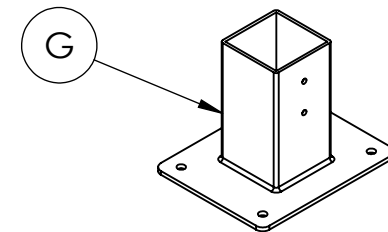

**1**  
Surface Mount Base

## REQUIRED TOOLS (NOT INCLUDED)

- 1 - 7/16" WRENCH
- 1 - #2 SQUARE BIT

**HARDWARE &  
TOOLS REQUIRED  
FOR ASSEMBLY**

**2/3**

# INSTRUCTIONS

## PW1010 - PW1012

### Inground Mount

- Dig a hole 12 inches in diameter to a depth of 18 inches
- Insert the inground mount (B) post into the hole
- Level the post with the ground
- Pour concrete into the hole and allow to set

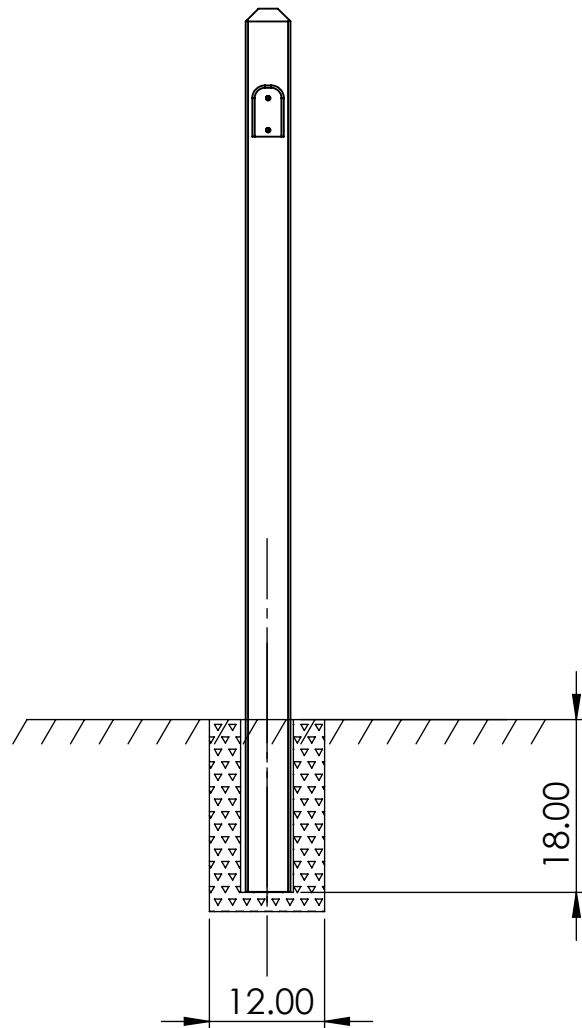

### Surface Mount

- Insert the post (C) into the surface mount base (G)
- Secure the post to the base with 2 1/4" x 1.5" lag screws (E) and washers (F) provided
- Place the post upright in desired location
- Square the post assembly to the ground
- Attach the surface mount base to the ground using appropriate hardware (not included)

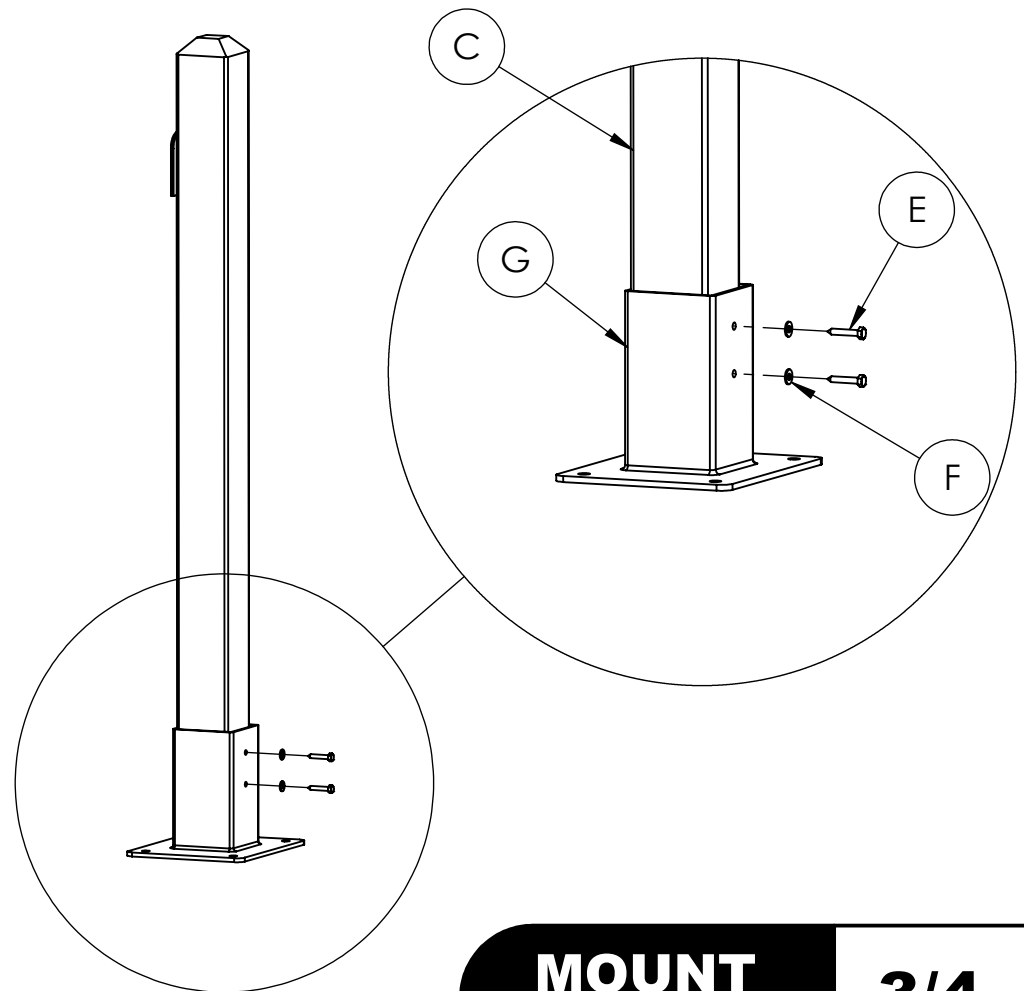

**MOUNT  
POST**

**3/4**

## INSTRUCTIONS PW1010 - PW1012

### MOUNT THE DISPENSER

- Slide the pet bags dispenser (A) onto the post
- Install the #10 x 2.5" screw to secure the dispenser to the post (Only 1 is needed but 2 are supplied in case of stripping)
- Remove bags from box and pull through slot

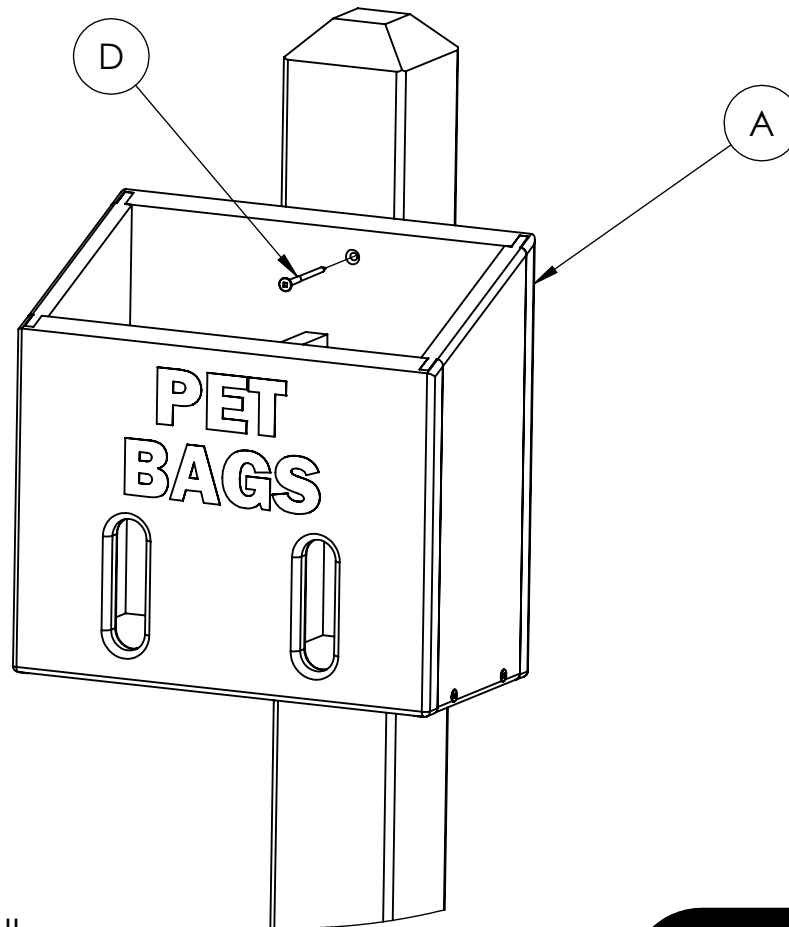

NOTE: LID REMOVED TO SHOW DETAIL

# PW1010- PW1012

NOTE: ALL MATERIAL IS RECYCLED PLASTIC LUMBER UNLESS NOTED  
ALL DIMENSIONS SHOWN IN INCHES

